



PACCHETTO

ROMAN-SHADE SYSTEMS



MOTTURA.COM

1

LAVAGGIO RAPIDO

Dal 1996, data del deposito del primo brevetto specifico, i sistemi per tende a pacchetto Mottura adottano soluzioni che permettono di rimuovere la tenda con estrema facilità e re-installarla con altrettanta rapidità dopo averne effettuato il lavaggio. I rocchetti avvolgitori sia della gamma Rotary che dei sistemi compatti Softbox sono progettati per rimuovere il telo unitamente ai suoi nastri/corde di sollevamento. Effettuato il lavaggio del telo, è sufficiente posizionarlo sul sistema per ripristinarne il funzionamento. Questa soluzione ha semplificato molto la manutenzione delle tende a pacchetto permettendo il loro utilizzo sia nel residenziale che nelle comunità.

FAST WASHING

Since 1996, when Mottura first patented their Roman Blind shade System which allowed the easy removal of the fabric from the system and the ability to re-install the fabric quickly after washing. The spools from the Rotary range and the Softbox systems have been designed so the fabric can be removed with the tapes /lift cords. After washing the curtain, it is easy to position it on the system and restore operation. This solution has significantly simplified the maintenance of the roman shades allowing their use in both residential and commercial locations.

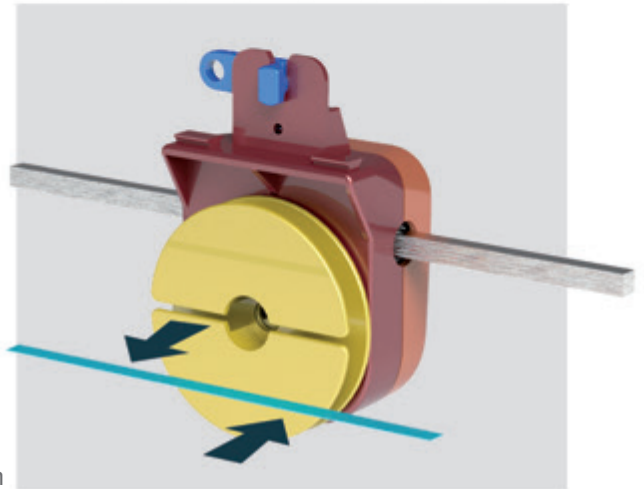

2

TENDE DI GRANDI DIMENSIONI

Rotary e Softbox, nella configurazione per grandi tende, sono dotati di meccanismi demoltiplicati (rapporto 1:4) che riducono lo sforzo dell'azionamento e permettono di azionare tende per grandi superfici.

LARGE ROMAN SHADES

The Rotary and Softbox systems for large blinds both have a gear down drive (1:4 Ratio). This reduces the effort required to operate a heavy blind.

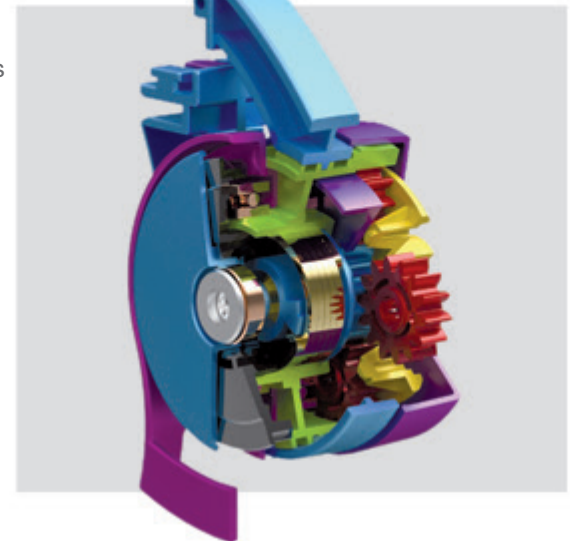

3

DESIGN & FUNZIONALITÀ

Mottura offre 17 diversi sistemi per tende a pacchetto; dai sistemi per installazione diretta su anta alle soluzioni motorizzate per grandi vetrate. Il concetto è Design & Funzionalità; il design quale priorità per i sistemi compatti, la funzionalità e la praticità per tutta la gamma.

DESIGN & FUNCTIONALITY

Mottura offers 17 different roman shade systems; solutions for direct installation on to the frame, to motorized systems for large windows. The concept for roman blind systems is Design & Functionality; the design is a priority for the compact systems, the functionality and practicality for the entire range.



4

M2NET

È la soluzione sviluppata da Mottura per la gestione dell'home automation. La gamma dei sistemi per tende a pacchetto azionate a motore digitale a basso consumo è M2net compatibile.

M2NET

It is the solution developed by Mottura for Home Automation Control. The motorized roman shades range is M2net compatible.

SISTEMI PER SERRAMENTO

FRAME'S INSTALLING SYSTEMS



BASIC 441

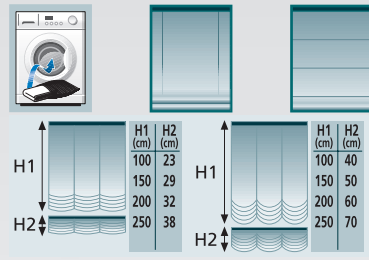
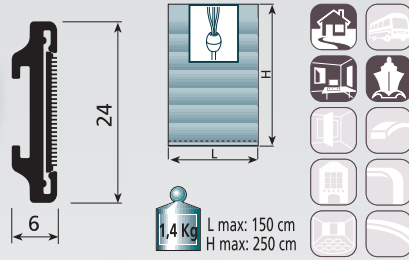

L (cm)	4092	4097
→ 60	2	2
61 → 110	3	3
111 → 150	4	4



BASIC 419

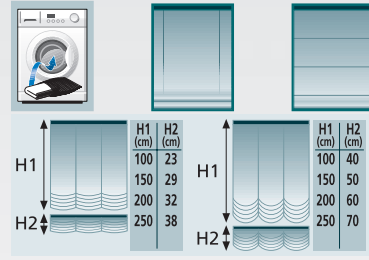
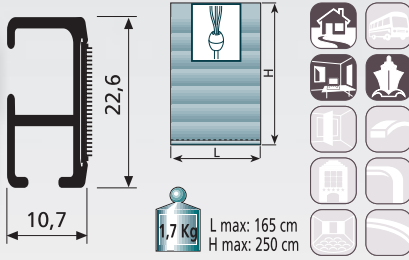

L (cm)	4558	4112
→ 60	2	2
61 → 110	3	3
111 → 165	4	4



BASIC 414

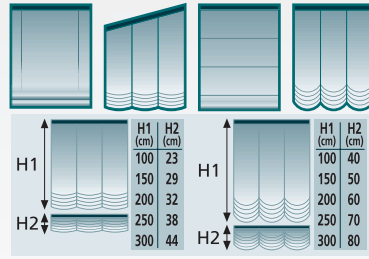
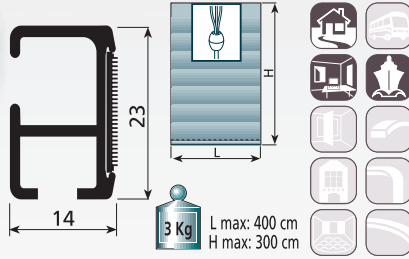

L (cm)	4127	4081
→ 60	2	2
61 → 110	3	2
111 → 165	4	3
166 → 215	5	3
216 → 265	6	4
266 → 315	7	4
316 → 340	7	5
341 → 365	8	5
366 → 400	9	5



ROTARY 439

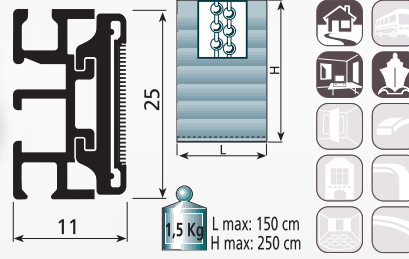

L (cm)	4429	4372 (4426)	4432
→ 660	2	2	1
61 → 110	3	3	2
111 → 140	4	4	2

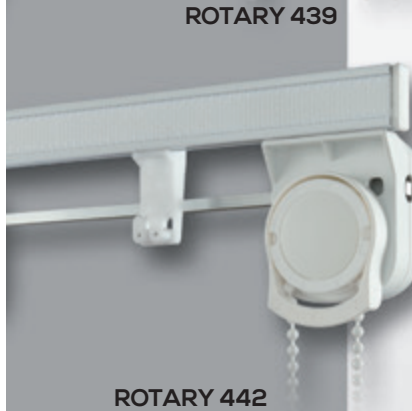

ROTARY 442

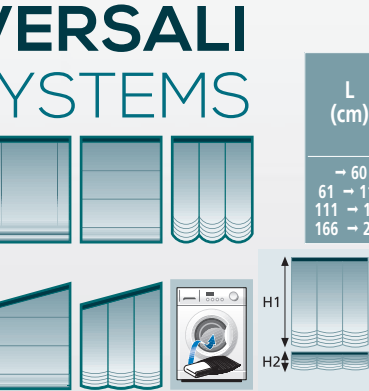
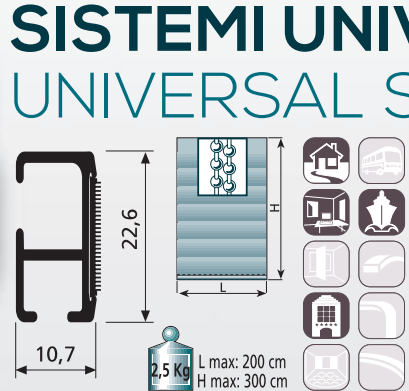

L (cm)	4549	4081 (...)	4566
→ 60	2	2	1
61 → 110	3	3	2
111 → 165	4	4	2
166 → 200	5	5	3



ROTARY 444

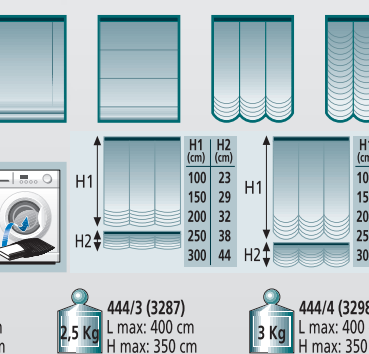
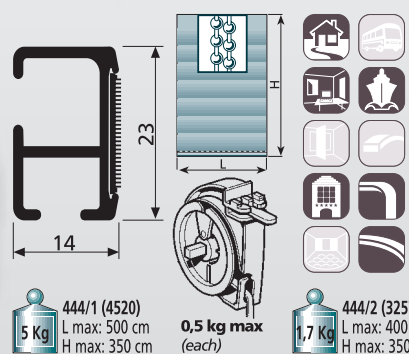

L (cm)	4081 (...)	3295
→ 70	2	2
71 → 110	3	3
111 → 165	4	4
166 → 215	5	5
216 → 265	6	6
266 → 340	7	7
341 → 365	8	8
366 → 400	9	9
401 → 445	10	10
446 → 500	11	11

444/1 (4520)
L max: 500 cm
H max: 350 cm

0,5 kg max (each)

444/2 (3257)
L max: 400 cm
H max: 350 cm

444/3 (3287)
L max: 400 cm
H max: 350 cm

444/4 (3298)
L max: 400 cm
H max: 350 cm

SISTEMI UNIVERSALI

UNIVERSAL SYSTEMS

SISTEMI UNIVERSALI UNIVERSAL SYSTEMS

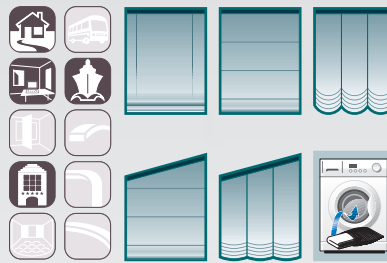
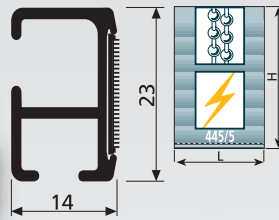

L (cm)	Accessories		
	4139	4081 (...)	3291
→ 60	2	2	1
61 → 110	3	3	2
111 → 165	4	4	2
166 → 215	5	5	3
216 → 265	6	6	3
266 → 315	7	7	4

5 Kg
445/1 (4520)
L max: 320 cm
H max: 320 cm

1,7 Kg
445/2 (3257)
L max: 320 cm
H max: 320 cm

2,5 Kg
445/3 (3287)
L max: 320 cm
H max: 320 cm

3 Kg
445/4 (3298)
L max: 320 cm
H max: 320 cm

8 Kg
445/5 (3260)
L max: 320 cm
H max: 320 cm

H1		H2		H1		H2	
(cm)	(cm)	(cm)	(cm)	(cm)	(cm)	(cm)	(cm)
100	23	100	40	100	40	100	40
150	29	150	50	150	50	150	50
200	32	200	60	200	60	200	60
250	38	250	70	250	70	250	70
300	44	300	80	300	80	300	80

ROTARY 445

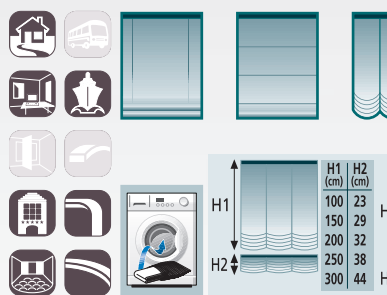
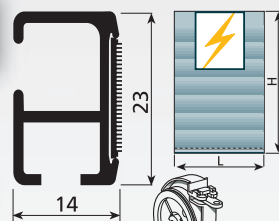

L (cm)	Accessories	
	4081(...)	3295
→ 70	2	2
71 → 110	3	3
111 → 165	4	4
166 → 215	5	5
216 → 265	6	6
266 → 340	7	7
341 → 365	8	8
366 → 400	9	9
401 → 445	10	10
446 → 500	11	11

8 Kg
L max: 500 cm
H max: 350 cm

0,5 kg max (each)

0,5 kg max (each)

H1		H2		H1		H2	
(cm)	(cm)	(cm)	(cm)	(cm)	(cm)	(cm)	(cm)
100	23	100	40	100	40	100	40
150	29	150	50	150	50	150	50
200	32	200	60	200	60	200	60
250	38	250	70	250	70	250	70
300	44	300	80	300	80	300	80

ROTARY 449

SISTEMI COMPATTI COMPACT SOFT SHADE SYSTEMS

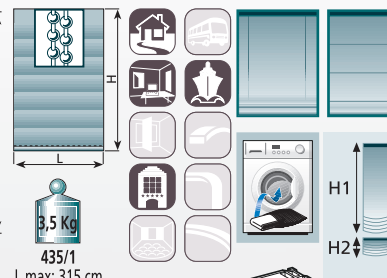
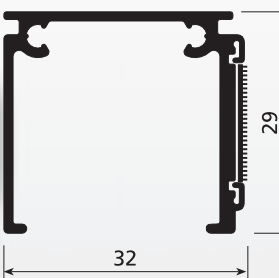

Softbox 435/1 L (cm)	Accessories	
	8051(...)	3261
→ 60	2	2
61 → 110	3	3
111 → 120	3	4
121 → 165	4	4
166 → 210	5	5
211 → 265	6	6
266 → 315	7	7

3,5 Kg
435/1
L max: 315 cm
H max: 300 cm

2 Kg
435/2
L max: 210 cm
H max: 250 cm

0,5 kg max (each)

0,5 kg max (each)

H1		H2		H1		H2	
(cm)	(cm)	(cm)	(cm)	(cm)	(cm)	(cm)	(cm)
100	23	100	40	100	40	100	40
150	29	150	50	150	50	150	50
200	32	200	60	200	60	200	60
250	38	250	70	250	70	250	70

SOFTBOX 435

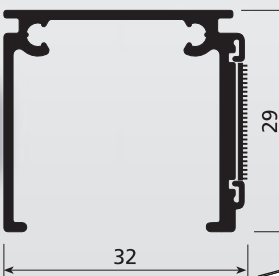

L (cm)	Accessories	
	8051(...)	3261
→ 110	3	3
111 → 165	4	4
166 → 210	5	5

2 Kg
L max: 210 cm
H max: 250 cm

0,5 kg max (each)

0,5 kg max (each)

H1		H2		H1		H2	
(cm)	(cm)	(cm)	(cm)	(cm)	(cm)	(cm)	(cm)
100	23	100	40	100	40	100	40
150	29	150	50	150	50	150	50
200	32	200	60	200	60	200	60
250	38	250	70	250	70	250	70

SOFTBOX 437

SISTEMI COMPATTI

COMPACT SOFT SHADE SYSTEMS

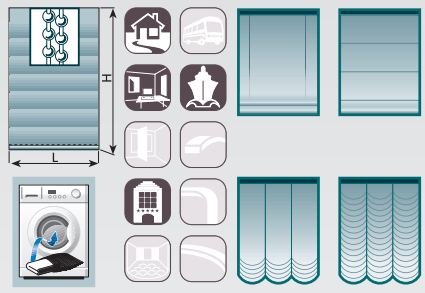
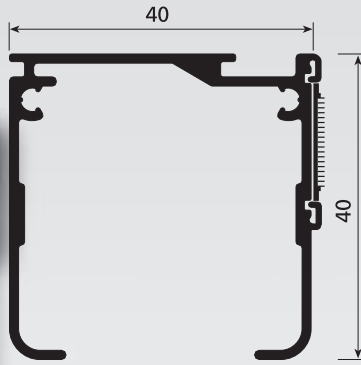

Softbox 440/1 L (cm)	3279	3272
- 60	2	2
61 - 110	3	3
111 - 165	4	4
166 - 215	5	5
216 - 265	6	6
266 - 340	7	7
341 - 365	8	8
366 - 400	9	9

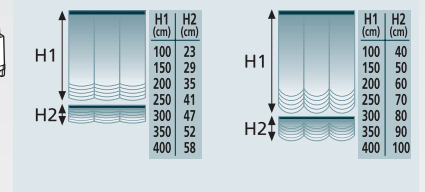

Softbox 440/2 L (cm)	3279	3272
- 60	2	2
61 - 110	3	3
111 - 165	4	4
166 - 215	5	5
216 - 265	6	6
266 - 340	7	7
341 - 365	8	8
366 - 400	9	9

SOFTBOX 440

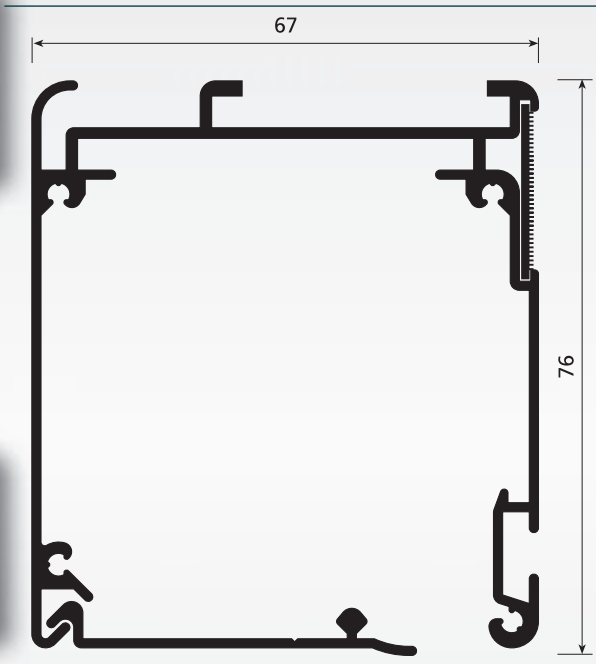

Softbox 467/1/2/3 L (cm)	4027(...)	4401
- 60	2	2
61 - 110	3	3
111 - 165	4	4
166 - 215	5	5
216 - 265	6	6
266 - 340	7	7
341 - 365	8	8
366 - 400	9	9
401 - 445	10	10
446 - 500	11	11
501 - 550	12	12
551 - 600	13	13
601 - 650	14	14
651 - 695	15	15

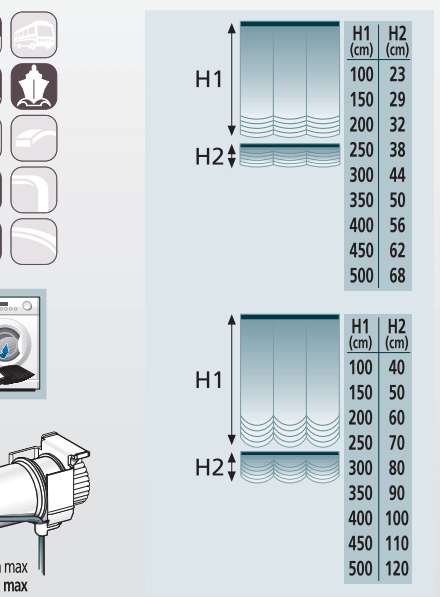
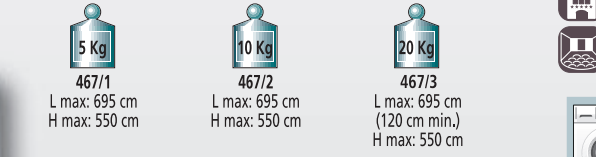
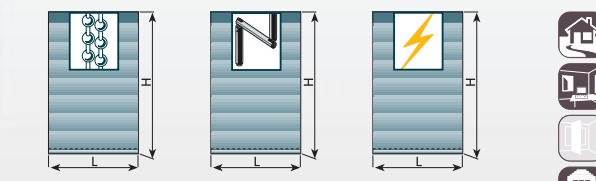

SOFTBOX 467/2

SOFTBOX 467/3

- Domestic**
Domestic
- Separazione ambienti**
Partitioning
- Grandi ambienti**
Meeting rooms
- Nautica**
Boats
- Docce**
Bathrooms
- Curva a 90°**
90° curve
- Uffici**
Offices
- Hotel**
Hotels
- Autobus, Caravan**
Autobus, Caravan
- Sospensione quadri**
Pictures hanging
- Arco**
Arch
- Curva ad ampio raggio**
Large radius curve

QBOX



QBOX 453

QBOX 457

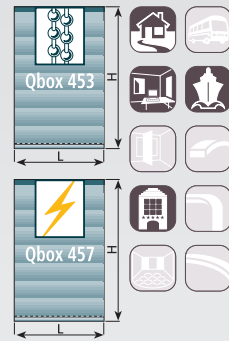
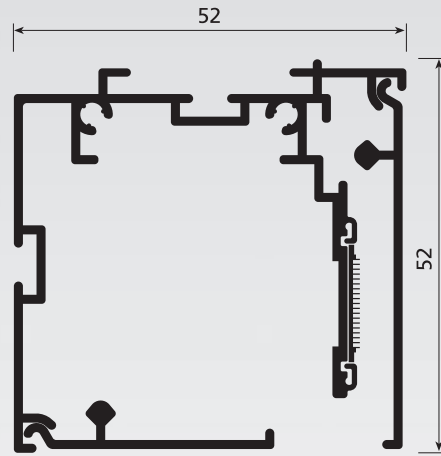

L (cm)	4232(...)	3271
→ 60	2	2
61 → 110	3	3
111 → 165	4	4
166 → 215	5	5
216 → 265	6	6
266 → 340	7	7
341 → 365	8	8
366 → 400	9	9

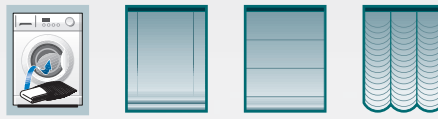
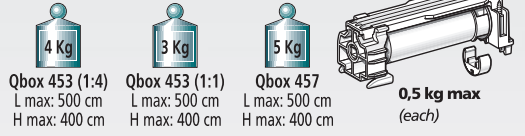

H1	H2	H1 (cm)	H2 (cm)
H1	H2	100	23
		150	29
H1	H2	200	32
		250	38

APPLICAZIONI SPECIALI SPECIAL APPLICATIONS



I sistemi per tende a pacchetto Mottura sono all'avanguardia nel mondo per la loro versatilità.

La gamma offre soluzioni per tende con curve concave o convesse ad ampio raggio, tende con curve ad angolo di 90° anche di rilevanti dimensioni ed anche tende ad arco.

Mottura roman shade systems are at the forefront of the world for their versatility. The range offers solutions for curtains with concave or convex bends, large radius curves, concave blinds with 90° bends, and it is also possible to have roman blinds in an arch shaped window.

ARRESTO BASCULANTE / TILTING STOPPER

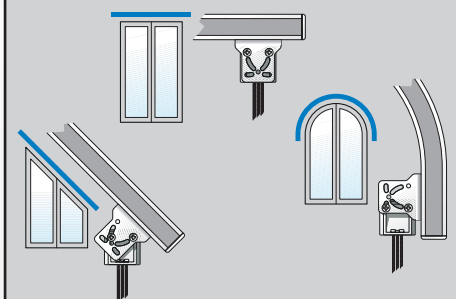

L'arresto 4116 è dotato di una piastra di ancoraggio al profilo in alluminio che permette ad esso di inclinarsi sino a raggiungere un orientamento a 90°, quindi parallelo al profilo velcro per installazioni su una volta a semicerchio.

The tilting stopper 4116 is fitted with one plate of anchorage to the aluminium profile, which allows it to tilt up and reach a 90° orientation, thus parallel to the Velcro® track for installations on a semi-circular ceiling.



Curva a 90°
90° curve

BASIC 414-427 - ROTARY 444
ROTARY 449



Curva ad ampio raggio
Large radius curve

BASIC 414-427 - ROTARY 444
ROTARY 449



Arco
Arch

BASIC 427



Inclinato
Sloped

ROTARY 442
ROTARY 445

INSTALLAZIONI INSTALLATIONS

BASIC 441

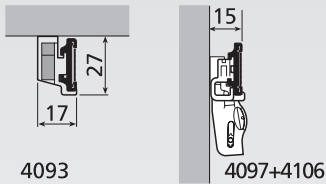

ROTARY 439

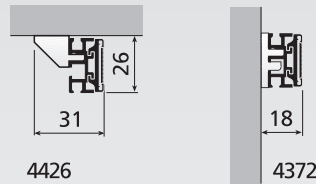

BASIC 419

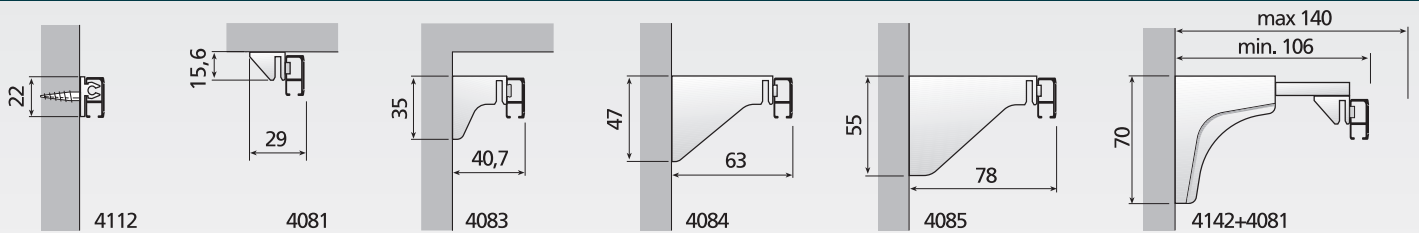

BASIC 414-427

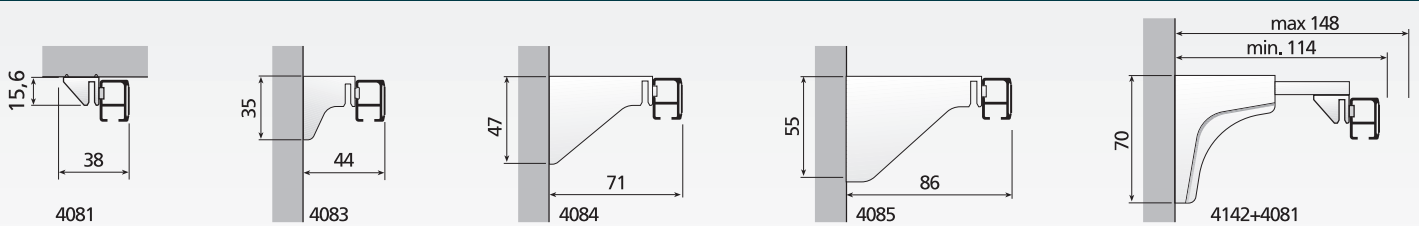

ROTARY 442

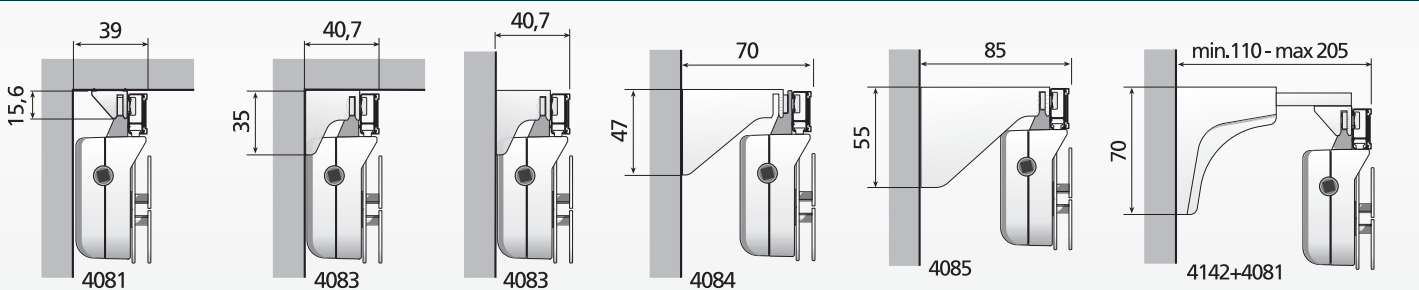

ROTARY 444-445

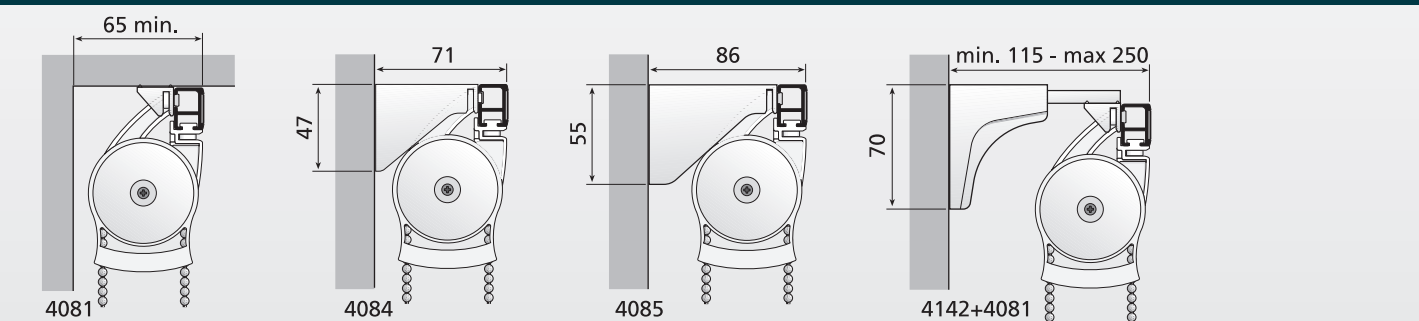

ROTARY 449

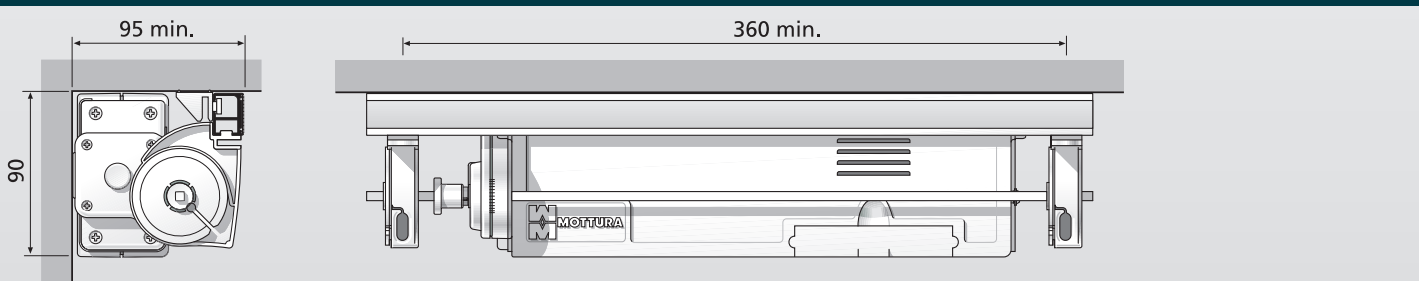

INSTALLAZIONI INSTALLATIONS

SOFTBOX 435-437

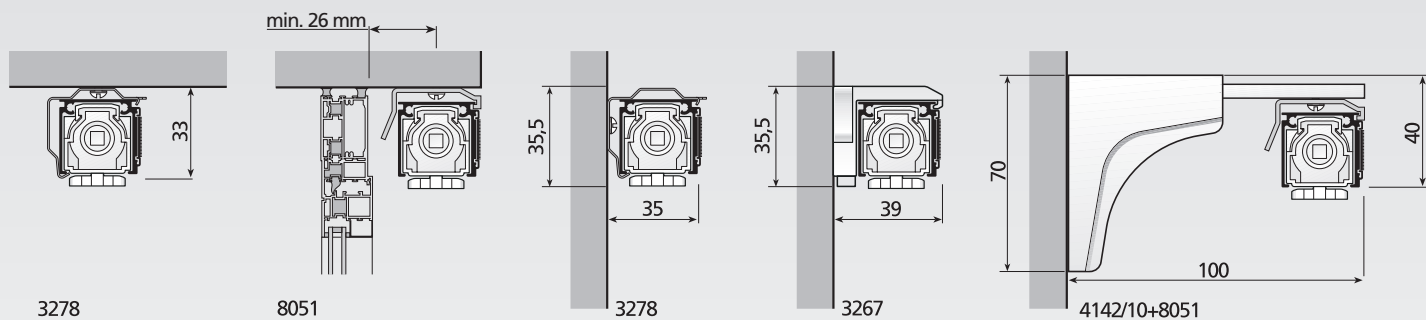

SOFTBOX 440

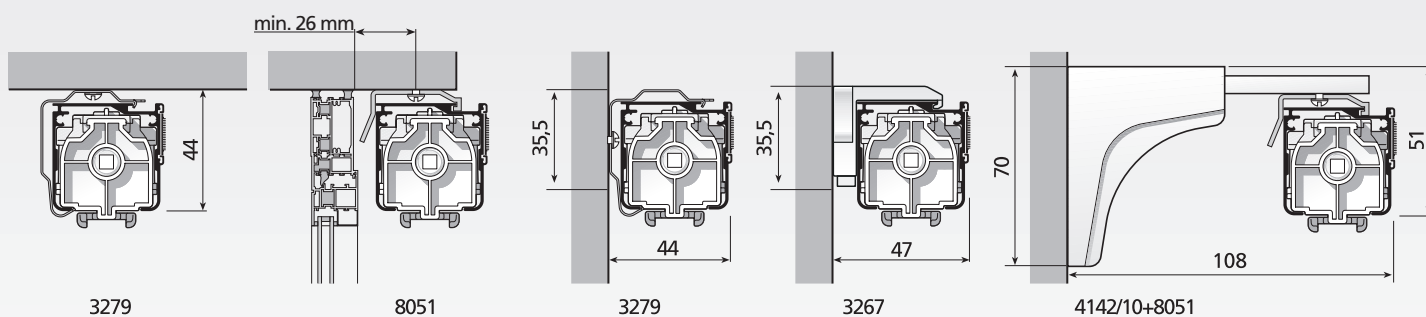

SOFTBOX 467

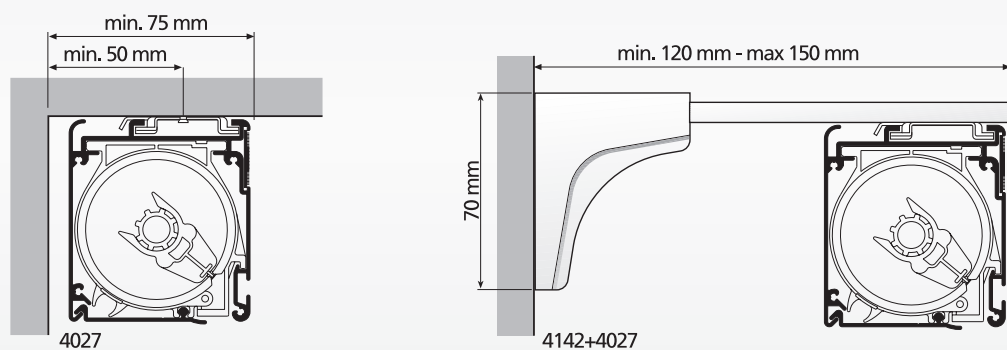

OBOX 453-457

